

**PART -1**  
**One-Mark Question**  
**MATHEMATICS**

1. Suppose  $\log_a b + \log_b a = c$ . The smallest possible integer value of  $c$  for all  $a, b > 1$  is -

- (A) 4 (B) 3 (C) 2 (D) 1

Ans. (C)

Sol.  $c = \log_a b + \frac{1}{\log_a b} \geq 2$

2. Suppose  $n$  is a natural number such that  $|i + 2i^2 + 3i^3 + \dots + ni^n| = 18\sqrt{2}$ , where  $i$  is the square root of  $-1$ .

Then  $n$  is -

- (A) 9 (B) 18 (C) 36 (D) 72

Ans. (C)

$$S = i + 2i^2 + 3i^3 + \dots + ni^n$$

Sol. 
$$\frac{iS = i^2 + 2i^3 + \dots + (n-1)i^n + ni^{n+1}}{S(1-i) = i + i^2 + i^3 + \dots + i^n - ni^{n+1}}$$

$$S(1-i) = \frac{i(1-i^n)}{1-i} - ni^{n+1} \Rightarrow S = \frac{1-i^n}{-2i} - \frac{ni^{n+1}}{1-i}$$

$$\downarrow \qquad \downarrow$$

$$z_1(\text{say}) \qquad z_2(\text{say})$$

$$|z_1| = \frac{1}{\sqrt{2}} \text{ or } 0 \quad |z_2| = \frac{n}{\sqrt{2}} = \frac{n}{2}\sqrt{2}$$

$$\frac{n}{2} = 18 \Rightarrow n = 36$$

3. Let  $P$  be an  $m \times m$  matrix such that  $P^2 = P$ . Then  $(1 + P)^n$  equals -

- (A)  $I + P$  (B)  $I + nP$  (C)  $I + 2^n P$  (D)  $I + (2^n - 1)P$

Ans. (D)

Sol.  $P^2 = P$   
 $P^{-1}P^2 = P^{-1}P$   
 $P = I$   
 $(I + P)^n = (2P)^n = 2^n P^n$   
 $= 2^n P$   
 $= P + (2^n - 1)P$   
 $= I + (2^n - 1)P$

4. Consider the cubic equation  $x^3 + ax^2 + bx + c = 0$ , where  $a, b, c$  are real numbers. Which of the following statements is correct ?

- (A) If  $a^2 - 2b < 0$ , then the equation has one real and two imaginary roots  
 (B) If  $a^2 - 2b \geq 0$ , then the equation has all real roots  
 (C) If  $a^2 - 2b > 0$ , then the equation has all real and distinct roots  
 (D) If  $4a^3 - 27b^2 > 0$ , then the equation has real and distinct roots

Ans. (A)

Sol.  $f(x) = x^3 + ax^2 + bx + c$

$$f'(x) = 3x^2 + 2ax + b$$

$$D = 4a^2 - 4 \cdot 3 \cdot b = 4(a^2 - 3b)$$

If  $a^2 < 2b \Rightarrow a^2 < 3b \Rightarrow D < 0 \Rightarrow f'(x) = 0$  has non real roots

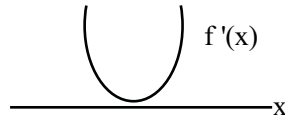

Hence  $f(x) = 0$  has 1 real and two imaginary roots

5. All the points  $(x, y)$  in the plane satisfying the equation  $x^2 + 2x \sin(xy) + 1 = 0$  lie on -

(A) a pair of straight lines

(B) a family of hyperbolas

(C) a parabola

(D) an ellipse

Ans. (A)

Sol.  $x^2 + 2x \sin(xy) + 1 = 0$

$$2 \sin(xy) = -\left(x + \frac{1}{x}\right)$$

$$\text{R.H.S.} \geq 2 \quad \text{or} \quad \leq -2$$

↓

↓

$$\text{L.H.S.} = \text{R.H.S.} = 2 \quad \sin(xy) = -1$$

↓

$$(x = 1)$$

$$x = -1$$

$$\sin(-y) = 1$$

$$\sin y = -1$$

$$\sin y = -1$$

$$y = 2n\pi - \frac{\pi}{2}, n \in I$$

Hence pair of straight lines.

6. Let  $A = (4, 0)$ ,  $B = (0, 12)$  be two points in the plane. The locus of a point  $C$  such that the area of triangle

$ABC$  is 18 sq. units is -

(A)  $(y + 3x + 12)^2 = 81$

(B)  $(y + 3x + 81)^2 = 12$

(C)  $(y + 3x - 12)^2 = 81$

(D)  $(y + 3x - 81)^2 = 12$

Ans. (C)

Sol.

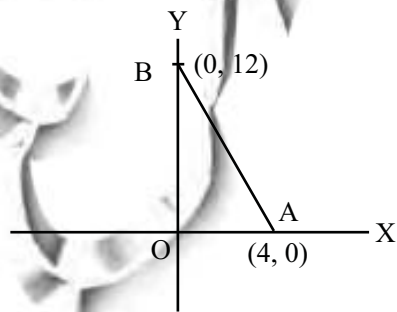

$$\frac{1}{2} \begin{vmatrix} 1 & x & y \\ 1 & 0 & 12 \\ 1 & 4 & 0 \end{vmatrix} = \pm 18$$

$$1(-48) - x(-12) + y(4) = \pm 36$$

$$12x + 4y - 48 = \pm 36$$

$$3x + y - 12 = \pm 9$$

$$(3x + y - 12)^2 = 81$$

7. In a rectangle  $ABCD$ , the coordinates of  $A$  and  $B$  are  $(1, 2)$  and  $(3, 6)$  respectively and some diameter of the circumscribing circle of  $ABCD$  has equation  $2x - y + 4 = 0$ . Then the area of the rectangle is -
- (A) 16                                      (B)  $2\sqrt{10}$                                       (C)  $2\sqrt{5}$                                       (D) 20

**Ans. (A)**  
**Sol.**

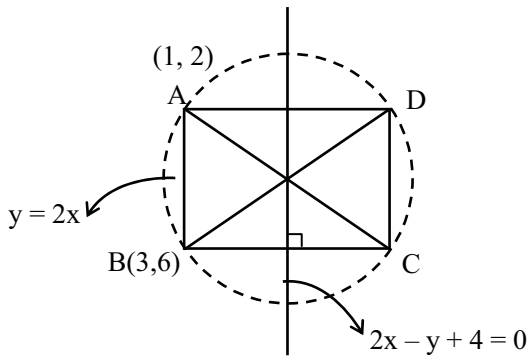

$$\text{Slope of } AB = \frac{4}{2} = 2$$

$$\text{slope of } BC = -\frac{1}{2}$$

$$\ell(AB) = \sqrt{4+16} = 2\sqrt{5}$$

$$\text{distance between } 2x - y + 4 = 0 \text{ \& } 2x - y = 0 \Rightarrow \frac{4}{\sqrt{5}}$$

$$\text{Area} = 2\sqrt{5} \cdot \frac{4}{\sqrt{5}} = 16$$

8. In the  $xy$ -plane, three distinct lines  $l_1, l_2, l_3$  concur at a point  $(\lambda, 0)$ . Further the lines  $l_1, l_2, l_3$  are normals to the parabola  $y^2 = 6x$  at the points  $A = (x_1, y_1), B = (x_2, y_2), C = (x_3, y_3)$  respectively. Then we have -
- (A)  $\lambda < -5$                                       (B)  $\lambda > 3$                                       (C)  $-5 < \lambda < -3$                                       (D)  $0 < \lambda < 3$

**Ans. (B)**  
**Sol.**

Any normal  
 $y = mx - 2am - am^3$  Here  $a = 3/2$

through  $(\lambda, 0)$

$$0 = m\lambda - 2am - am^3$$

$$m = 0, \quad \lambda = 2a + am^2$$

$$m^2 = \frac{\lambda}{a} - 2 > 0$$

$$\lambda > 2a \Rightarrow \lambda > 3$$

9. Let  $f(x) = \cos 5x + A \cos 4x + B \cos 3x + C \cos 2x + D \cos x + E$ , and  
 $T = f(0) - f\left(\frac{\pi}{5}\right) + f\left(\frac{2\pi}{5}\right) - f\left(\frac{3\pi}{5}\right) + \dots + f\left(\frac{8\pi}{5}\right) - f\left(\frac{9\pi}{5}\right)$ . Then  $T$   
 (A) depends on  $A, B, C, D, E$   
 (B) depends on  $A, C, E$  but independent of  $B$  and  $D$   
 (C) depends on  $B, D$  but independent of  $A, C, E$   
 (D) is independent of  $A, B, C, D, E$

Ans. (C)

Sol. Clearly  $f(\pi + x) + f(\pi - x)$  (every term contain cosine)

$$f\left(\frac{\pi}{5}\right) = f\left(\frac{9\pi}{5}\right), f\left(\frac{2\pi}{5}\right) = f\left(\frac{8\pi}{5}\right), f\left(\frac{3\pi}{5}\right) = f\left(\frac{7\pi}{5}\right)$$

$$f\left(\frac{4\pi}{5}\right) = f\left(\frac{6\pi}{5}\right)$$

$$T = f(0) - 2 \left[ f\left(\frac{\pi}{5}\right) + f\left(\frac{3\pi}{5}\right) \right] + 2 \left[ f\left(\frac{2\pi}{5}\right) + f\left(\frac{4\pi}{5}\right) \right] - f(\pi)$$

$$f(0) - f(\pi) = 2(1 + B + D)$$

$$f\left(\frac{\pi}{5}\right) + f\left(\frac{3\pi}{5}\right) = f\left(\frac{\pi}{5}\right) - f\left(\frac{4\pi}{5}\right) = 2 \left( 1 + B \cos \frac{3\pi}{5} + D \cos \frac{\pi}{5} \right)$$

$$f\left(\frac{2\pi}{5}\right) + f\left(\frac{4\pi}{5}\right) = f\left(\frac{2\pi}{5}\right) - f\left(\frac{3\pi}{5}\right) = 2 \left( 1 + B \cos \frac{6\pi}{5} + D \cos \frac{2\pi}{5} \right)$$

$T \Rightarrow$  contains only  $B, D$  terms

10. In triangle  $ABC$ , we are given that  $3 \sin A + 4 \cos B = 6$  and  $4 \sin B + 3 \cos A = 1$ . Then the measure of the angle  $C$  is -  
 (A)  $30^\circ$  (B)  $150^\circ$  (C)  $60^\circ$  (D)  $75^\circ$

Ans. (A)

Sol. Square & add both equations

$$9 + 16 + 24 \sin(A + B) = 37$$

$$\sin(A + B) = \frac{1}{2} \Rightarrow A + B = \frac{\pi}{6} \Rightarrow C = \frac{5\pi}{6} \text{ (wrong)}$$

$$\Rightarrow A + B = \frac{5\pi}{6} \Rightarrow C = \frac{\pi}{6}$$

$$\text{because } C = \frac{5\pi}{6}$$

does not follow equation  $3 \sin A + 4 \cos B = 6$

11. Which of the following intervals is a possible domain of the function  $f(x) = \log_{\{x\}} [x] + \log_{[x]} \{x\}$ , where  $[x]$  is the greatest integer not exceeding  $x$  and  $\{x\} = x - [x]$ ?  
 (A)  $(0, 1)$  (B)  $(1, 2)$  (C)  $(2, 3)$  (D)  $(3, 5)$

Ans. (C)

Sol.  $x \notin \mathbb{I}$  &  $[x] > 1$

$\Rightarrow x \in (2, 3)$  only option satisfy.

12. If  $f(x) = (2011 + x)^n$ , where  $x$  is a real variable and  $n$  is a positive integer, then the value of  $f(0) + f'(0) + \frac{f''(0)}{2!} + \dots + \frac{f^{(n-1)}(0)}{(n-1)!}$  is -

- (A)  $(2011)^n$                       (B)  $(2012)^n$                       (C)  $(2012)^n - 1$                       (D)  $n(2011)^n$

Ans. (C)

Sol.  $(2011)^n + {}^nC_1(2011)^{n-1} + {}^nC_2(2011)^{n-2} + \dots + {}^nC_{n-1}2011 + {}^nC_n$   
 $= (2011 + 1)^n - 1$

13. The minimum distance between a point on the curve  $y = e^x$  and a point on the curve  $y = \log_e x$  is -

- (A)  $\frac{1}{\sqrt{2}}$                       (B)  $\sqrt{2}$                       (C)  $\sqrt{3}$                       (D)  $2\sqrt{2}$

Ans. (B)

Sol.

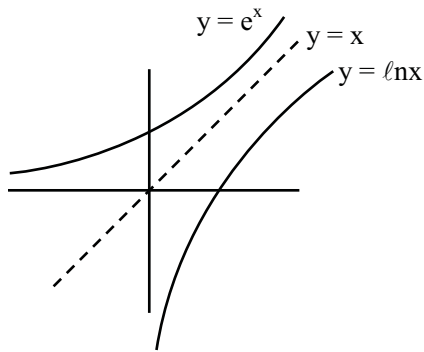

II<sup>nd</sup> curve

$$y' = \frac{1}{x}$$

$x = 1 \Rightarrow$  point  $(1, 0)$

similarly Ist  $\Rightarrow$  point  $(0, 1)$

distance  $= \sqrt{2}$

14. Let  $f: (2, \infty) \rightarrow N$  be defined by  $f(x) =$  the largest prime factor of  $[x]$ . Then  $\int_2^8 f(x) dx$  is equal to -

- (A) 17                      (B) 22                      (C) 23                      (D) 25

Ans. (B)

Sol.  $\int_2^8 f(x) dx = 2 + 3 + 2 + 5 + 3 + 7 = 22$

15. Let  $[x]$  denote the largest integer not exceeding  $x$  and  $\{x\} = x - [x]$ . Then  $\int_0^{2012} \frac{e^{\cos(\pi\{x})}}{e^{\cos(\pi\{x})} + e^{-\cos(\pi\{x})}} dx$  is equal to -

- (A) 0                      (B) 1006                      (C) 2012                      (D) 2012 $\pi$

Ans. (B)

Sol.  $I = 2012 \int_0^1 \frac{e^{\cos \pi x}}{e^{\cos \pi x} + e^{-\cos \pi x}} dx$

using king property  $I = 2012 \int_0^1 \frac{e^{-\cos \pi x}}{e^{-\cos \pi x} + e^{\cos \pi x}} dx \Rightarrow 2I = 2012 \Rightarrow I = 1006$

16. The value of  $\lim_{n \rightarrow \infty} \left( \frac{1}{\sqrt{4n^2 - 1}} + \frac{1}{\sqrt{4n^2 - 4}} + \dots + \frac{1}{\sqrt{4n^2 - n^2}} \right)$  is -

- (A)  $\frac{1}{4}$                       (B)  $\frac{\pi}{12}$                       (C)  $\frac{\pi}{4}$                       (D)  $\frac{\pi}{6}$

Ans. (D)

Sol. 
$$\lim_{n \rightarrow \infty} \sum_{r=1}^n \frac{1}{\sqrt{4n^2 - r^2}} = \lim_{n \rightarrow \infty} \frac{1}{n} \sum_{r=1}^n \frac{1}{\sqrt{4 - (r/n)^2}}$$

$$= \int_0^1 \frac{dx}{\sqrt{4 - x^2}} = \left( \sin^{-1} \left( \frac{x}{2} \right) \right)_0^1 = \frac{\pi}{6}$$

17. Two players play the following game : A writes 3, 5, 6 on three different cards ; B writes 8, 9, 10 on three different cards. Both draw randomly two cards from their collections. Then A computes the product of two numbers he/she has drawn, and B computes the sum of two numbers he/she has drawn. The player getting the larger number wins. What is the probability that A wins ?

- (A)  $\frac{1}{3}$                       (B)  $\frac{5}{9}$                       (C)  $\frac{4}{9}$                       (D)  $\frac{1}{9}$

Ans. (C)

Sol. For A to win, A can draw either 3, 6 or 5, 6. If A draws 3, 6 then B can draw only 8 & 9

$$\text{Prob.} = \frac{1}{3} \cdot \frac{1}{3} = \frac{1}{9}$$

If A draws 5, 6 then B can draw, any two

$$\text{Probability} = \frac{1}{3} \cdot 1 = \frac{1}{3}$$

$$\text{Probability} = \frac{1}{9} + \frac{1}{3} = \frac{4}{9}$$

18. Let  $\vec{a}, \vec{b}, \vec{c}$  be three vectors in the xyz space such that  $\vec{a} \times \vec{b} = \vec{b} \times \vec{c} = \vec{c} \times \vec{a} \neq 0$  If A, B, C are points with position vectors  $\vec{a}, \vec{b}, \vec{c}$  respectively, then the number of possible positions of the centroid of triangle ABC is -

- (A) 1                      (B) 2                      (C) 3                      (D) 6

Ans. (A)

Sol.  $\vec{a} \times \vec{b} + \vec{c} \times \vec{b} = 0$  similarly  $\vec{b} + \vec{c} = \lambda_2 \vec{a}$

$$\vec{a} + \vec{c} = \lambda_1 \vec{b} \quad \vec{b} + \vec{a} = \lambda_3 \vec{c}$$

$$\text{Hence } \vec{a} + \vec{b} + \vec{c} = \vec{0}$$

⇓

only 1 position of centroid

19. The sum of  $(1^2 - 1 + 1)(1!) + (2^2 - 2 + 1)(2!) + \dots + (n^2 - n + 1)(n!)$  is -

- (A)  $(n + 2)!$                       (B)  $(n - 1)((n + 1)!) + 1$                       (C)  $(n + 2)! - 1$                       (D)  $n((n + 1)!) - 1$

Ans. (B)

Sol. 
$$T_n = (n^2 - n + 1) n!$$

$$= (n^2 - 1) n! - (n - 2) n!$$

$$T_n = (n - 1) (n + 1) ! - (n - 2) n!$$

$$\text{Sum} = 1 + (n - 1) (n + 1) !$$

20. Let  $X$  be a nonempty set and let  $P(X)$  denote the collection of all subsets of  $X$ . Define

$$f: X \times P(X) \rightarrow R \text{ by}$$

$$f(x, A) = \begin{cases} 1, & \text{if } x \in A \\ 0, & \text{if } x \notin A \end{cases}$$

Then  $f(x, A \cup B)$  equals -

- (A)  $f(x, A) + f(x, B)$  (B)  $f(x, A) + f(x, B) - 1$   
 (C)  $f(x, A) + f(x, B) - f(x, A)f(x, B)$  (D)  $f(x, A) + |f(x, A) - f(x, B)|$

Ans. (C)

Sol.  $f(x, A \cup B) = \begin{cases} 1 & \text{if } x \in A \cup B \\ 0 & \text{if } x \notin A \cup B \end{cases}$

$$\left. \begin{array}{l} \text{if } x \in A, x \in B \\ \text{if } x \in A, x \notin B \\ \text{if } x \notin A, x \in B \end{array} \right\} \Rightarrow f(x, A \cup B) = 1 \Rightarrow \text{None of the option (A, B, D) satisfy}$$

$$\text{if } x \notin A, x \notin B \Rightarrow f(x, A \cup B) = 0 \Rightarrow \text{C (only C satisfy)}$$

## PHYSICS

21. A narrow but tall cabin is falling freely near the earth's surface. Inside the cabin, two small stones  $A$  and  $B$  are released from rest (relative to the cabin). Initially  $A$  is much above the centre of mass and  $B$  much below the centre of mass of the cabin. A close observation of the motion of  $A$  and  $B$  will reveal that -

- (A) both  $A$  and  $B$  continue to be exactly at rest relative to the cabin  
 (B)  $A$  moves slowly upward and  $B$  moves slowly downward relative to the cabin  
 (C) both  $A$  and  $B$  fall to the bottom of the cabin with constant acceleration due to gravity  
 (D)  $A$  and  $B$  move slightly towards each other vertically

Ans. (B)

Sol.



$$a_B > a_C > a_A$$

$$a_B = g$$

$$\vec{a}_{A/CM} = \vec{a}_A - \vec{a}_{CM} (\uparrow)$$

$$\vec{a}_{B/CM} = \vec{a}_B - \vec{a}_{CM} (\downarrow)$$

22. Two plates each of the mass  $m$  are connected by a massless spring as shown.

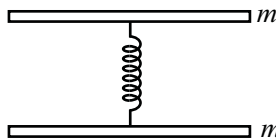

A weight  $W$  is put on the upper plate which compresses the spring further. When  $W$  is removed, the entire assembly jumps up. The minimum weight  $W$  needed for the assembly to jump up when the weight is removed is just more than -

- (A)  $mg$  (B)  $2mg$  (C)  $3mg$  (D)  $4mg$

**Ans. (B)**

**Sol.** For lower block +ve lift,  $kx \geq mg$

$$\Rightarrow x \geq \frac{mg}{k}$$

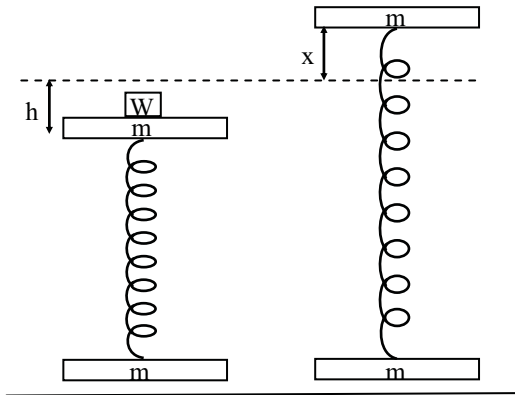

W/E theorem

$$-mg(h+x) + \left( \frac{1}{2}kh^2 - \frac{1}{2}kx^2 \right) = 0 - 0$$

$$\Rightarrow -mgh - \frac{m^2g^2}{k} + \frac{1}{2}kh^2 - \frac{1}{2} \frac{m^2g^2}{k} = 0$$

$$\frac{kh^2}{2} - mgh - \frac{3m^2g^2}{2k} = 0$$

$$h = \frac{mg \pm \sqrt{m^2g^2 + 3m^2g^2}}{k}$$

$$= \frac{mg \pm 2mg}{k} = \frac{3mg}{k}, \frac{-mg}{k}$$

$$\therefore h = \frac{3mg}{k}$$

$$W + mg = kh$$

$$W + mg = 3mg$$

$$W = 2mg$$

23. If the speed ( $v$ ) of the bob in a simple pendulum is plotted against the tangential acceleration ( $a$ ), the correct graph will be represented by -

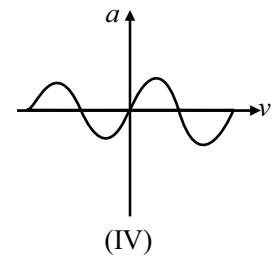
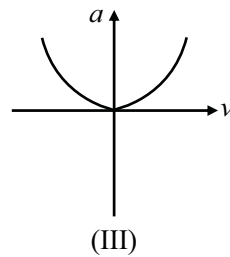
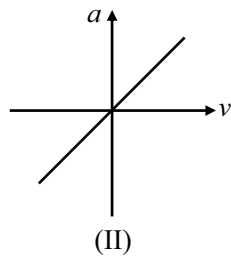
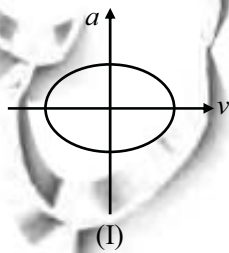

(A) I

(B) II

(C) III

(D) IV

**Ans. (A)**

**Sol.** In SHM  
 $a = -\omega^2 x$



$$v = \omega \sqrt{A^2 - x^2}$$

$$v^2 = \omega^2 (A^2 - x^2)$$

$$v^2 = \omega^2 A^2 - \omega^2 \times \frac{a^2}{\omega^2}$$

$$v^2 + \frac{a^2}{\omega^2} = \omega^2 A^2$$

$$\frac{v^2}{\omega^2 A^2} + \frac{a^2}{\omega^4 A^2} = 1$$

i.e. ellipse

24. A container with rigid walls is covered with perfectly insulating material. The container is divided into two parts by a partition. One part contains a gas while the other is fully evacuated (vacuum). The partition is suddenly removed. The gas rushes to fill the entire volume and comes to equilibrium after a little time. If the gas is **not** ideal,

- (A) the initial internal energy of the gas equals its final internal energy
- (B) the initial temperature of the gas equals its final temperature
- (C) the initial pressure of the gas equals its final pressure
- (D) the initial entropy of the gas equals its final entropy

Ans. (A)

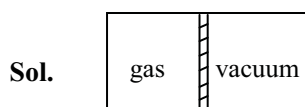

expansion is against

vacuum  $\therefore \Delta W = 0$

Insulated container  $\therefore \Delta Q = 0$

First law of thermodynamics

$$\Delta Q = \Delta W + \Delta U$$

$$0 = 0 + \Delta U$$

$$0 = 0 + \Delta U$$

$$\Delta U = 0$$

25. Two bulbs of identical volumes connected by a small capillary are initially filled with an ideal gas at temperature T. Bulb 2 is heated to maintain a temperature 2T while bulb 1 remains at temperature T. Assume throughout that the heat conduction by the capillary is negligible. Then the ratio of final mass of the gas in bulb 2 to the initial mass of the gas in the same bulb is close to -

- (A) 1/2
- (B) 2/3
- (C) 1/3
- (D) 1

Ans. (B)

Sol. Mole conservation

$$n_1 + n_2 = n$$

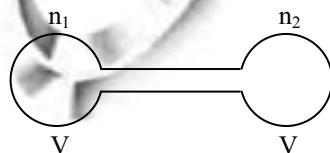

$$\text{Initial no. of moles} = n_1 = n_2 = \frac{n}{2}$$

finally when temp of 1 vessel is T & another is 2T

$$n_1 = \frac{PV}{RT}$$

$$n_2 = \frac{PV}{R2T} \Rightarrow \frac{n_1}{n_2} = \frac{2}{1}$$

$$n_1 + n_2 = n$$

$$n_1 = \frac{2n}{3}; n_2 = \frac{n}{3}$$

mass of gas  $\propto n_1$

$$\therefore \frac{M_2}{M_1} = \frac{\frac{n}{3}}{\frac{2n}{3}} = \frac{2}{3}$$

26. Two rods, one made of copper and the other steel of the same length and cross sectional area are joined together. (The thermal conductivity of copper is  $385 \text{ J.s}^{-1}.\text{m}^{-1}.\text{K}^{-1}$  and steel is  $50 \text{ J.s}^{-1}.\text{m}^{-1}.\text{K}^{-1}$ .) If the copper end is held at  $100^\circ\text{C}$  and the steel end is held at  $0^\circ\text{C}$ , what is the junction temperature (assuming no other heat losses) ?

(A)  $12^\circ\text{C}$  (B)  $50^\circ\text{C}$  (C)  $73^\circ\text{C}$  (D)  $88^\circ\text{C}$

Ans. (D)

Sol. 
$$\frac{100 - T}{R_1} = \frac{T - 0}{R_2}$$

$$\frac{100 - T}{T} = \frac{R_1}{R_2}$$

$$R = \frac{L}{KA}$$

$$\frac{R_1}{R_2} = \frac{k_2}{k_1}$$

$$\frac{100 - T}{T} = \frac{50}{385} = \frac{10}{77}$$

$$7700 - 77T = 10T$$

$$7700 = 87T$$

$$T = \frac{7700}{87} = 88^\circ\text{C}$$

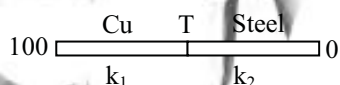

27. Jet aircrafts fly at altitudes above 30,000 ft where the air is very cold at  $-40^\circ\text{C}$  and the pressure is 0.28 atm. The cabin is maintained at 1 atm pressure by means of a compressor which exchanges air from outside adiabatically. In order to have a comfortable cabin temperature of  $25^\circ\text{C}$ , we will require in addition -

(A) a heater to warm the air injected into the cabin  
 (B) an air-conditioner to cool the air injected into the cabin  
 (C) neither a heater nor an air-conditioner ; the compressor is sufficient  
 (D) alternatively heating and cooling in the two halves of the compressor cycle

Ans. (B)

Sol.  $PV^\gamma = C$

$$P^{1-\gamma} T^\gamma = C$$

$$(0.28)^{1-\gamma} \times (233)^\gamma = 1^{1-\gamma} \times T^\gamma$$

$$\gamma = \frac{7}{5}$$

$$(0.28)^{1-7/5} \times (233)^{7/5} = 1^{1-7/5} \times T^{7/5}$$

$$T^{7/5} = 233^{7/5} \times (0.28)^{2/5}$$

$$T = 233 (0.28)^{2/7}$$

$$T = \frac{233}{(0.28)^{2/7}}$$

T is coming

more than 298 K or 25°C

∴ T is more than 25°C

so to cool it an extra ac is required.

28. A speaker emits a sound wave of frequency  $f_0$ . When it moves towards a stationary observer with speed  $u$ , the observer measures a frequency  $f_1$ . If the speaker is stationary, and the observer moves towards it with speed  $u$ , the measured frequency is  $f_2$ . Then -

(A)  $f_1 = f_2 < f_0$

(B)  $f_1 > f_2$

(C)  $f_1 < f_2$

(D)  $f_1 = f_2 > f_0$

Ans. (B)

Sol. S • → u      • O

$$f_1 = \frac{f_0 [v]}{v - u}$$

S •                  v ← • O

$$f_2 = f_0 \frac{[v + u]}{v}$$

$$f_2 - f_1 = f_0 \left( \frac{u + v}{v} - \frac{v}{v - u} \right)$$

$$f_2 - f_1 = \frac{-u^2 f_0}{(v)(v - u)} = -ve$$

$$\therefore f_1 > f_2$$

29. A plane polarized light passed through successive polarizers which are rotated by 30° with respect to each other in the clockwise direction. Neglecting absorption by the polarizers and given that the first polarizer's axis is parallel to the plane of polarization of the incident light, the intensity of light at the exit of the fifth polarizer is closest to -

(A) same as that of the incident light

(B) 17.5% of the incident light

(C) 30% of the incident light

(D) zero

Ans. (C)

Sol.  $I = I_0 (\cos^2 \phi)^4$

$$= I_0 \times \left(\frac{3}{4}\right)^4 = 30\% \text{ of } I_0$$

30. At 23°C, a pipe open at both ends resonates at a frequency of 450 hertz. At what frequency does the same pipe resonate on a hot day when the speed of sound is 4 percent higher than it would be at 23°C ?  
 (A) 446 Hz (B) 454 Hz (C) 468 Hz (D) 459 Hz

Ans. (C)

Sol.  $f\lambda = v$

$$f \propto v$$

$$\frac{f_1}{f_2} = \frac{v_1}{v_2}$$

$$\frac{450}{f_2} = \frac{v_1}{1.04v_1}$$

$$f_2 = 1.04 \times 450$$

$$= 468\text{Hz.}$$

31. In a Young's double slit set-up, light from a laser source falls on a pair of very narrow slits separated by 1.0 micrometer and bright fringes separated by 1.0 millimeter are observed on a distant screen. If the frequency of the laser light is doubled, what will be the separation of the bright fringes ?  
 (A) 0.25 mm (B) 0.5 mm (C) 1.0 mm (D) 2.0 mm

Ans. (B)

Sol. Separation

$$\text{Bright fringe} = \frac{\lambda D}{d}$$

$$f\lambda = c$$

If f is doubled

$\lambda$  become halved

$\therefore \beta$  become half

$$\beta = \frac{1}{2} = 0.5 \text{ mm}$$

32. For a domestic AC supply of 220 V at 50 cycles per second, the potential difference between the terminals of a two pin electric outlet in a room is given by -

(A)  $V(t) = 220\sqrt{2} \cos(100\pi t)$

(B)  $V(t) = 220 \cos(50 t)$

(C)  $V(t) = 220 \cos(100 \pi t)$

(D)  $V(t) = 220\sqrt{2} \cos(50 t)$

Ans. (A)

Sol. R.M.S. value = 220 V

$$\text{Peak value} = 220\sqrt{2}$$

$$\omega = 2\pi n$$

$$= 2\pi \times 50$$

$$= 100 \pi$$

$$V(t) = 220\sqrt{2} \cos(100\pi t)$$

33. In the circuit shown below the resistance are given in ohms and the battery is assumed ideal with emf equal to 3.0 volts. The resistor that dissipates the most power is -

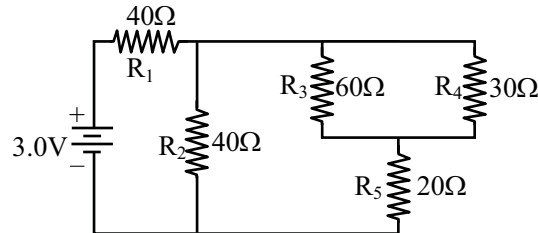

- (A)  $R_1$                       (B)  $R_2$                       (C)  $R_3$                       (D)  $R_4$

Ans. (A)

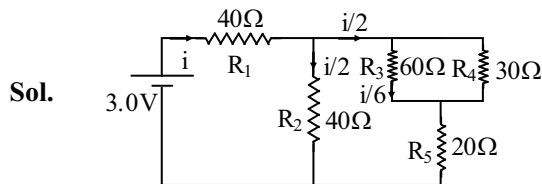

Power dissipate in  $R_1$  is maximum as its current is maximum and its resistance is also  $40\Omega$  which is higher than  $R_5R_4$ .

34. An electron collides with a free molecules initially in its ground state. The collision leaves the molecules in an excited state that is metastable and does not decay to the ground state by radiation. Let  $K$  be the sum of the initial kinetic energies of the electron and the molecule, and  $\vec{P}$  the sum of their initial momenta. Let  $K'$  and  $\vec{P}'$  represent the same physical quantities after the collision. Then -

- (A)  $K = K', \vec{P} = \vec{P}'$                       (B)  $K' < K, \vec{P} = \vec{P}'$                       (C)  $K = K', \vec{P} \neq \vec{P}'$                       (D)  $K' < K, \vec{P} \neq \vec{P}'$

Ans. (B)

Sol. Collision of e lead to excitation of molecules so Collision is inelastic  
 $\therefore K' < K$  and loss of kinetic energy go for excitation of molecules. Momentum remain conserved during collision.

$$\vec{P} = \vec{P}'$$

35. In the circuit shown, the switch is closed at time  $t = 0$ .

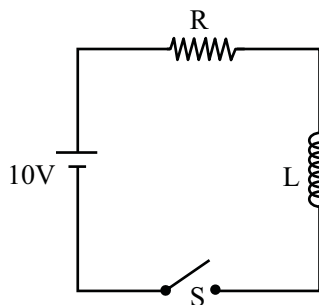

Which of the graphs shown below best represents the voltage across the inductor, as seen on an oscilloscope ?

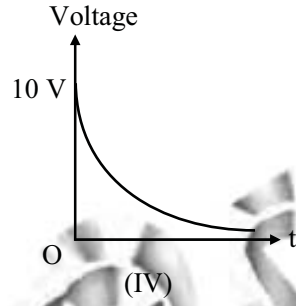
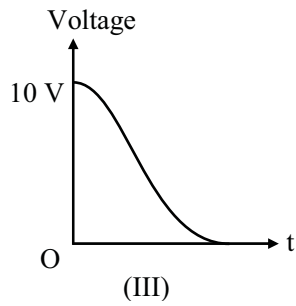
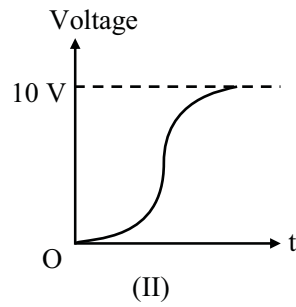
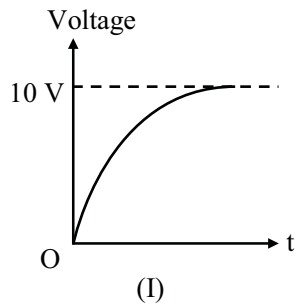

(A) I

(B) II

(C) III

(D) IV

Ans.

(D)

Sol.

$$|e| = \frac{V}{R} e^{-\frac{R}{L} \times t}$$

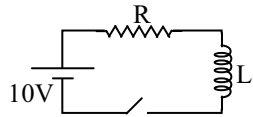

36.

Given below are three schematic graphs of potential energy  $V(r)$  versus distance  $r$  for three atomic particles : electron ( $e^-$ ), proton ( $p^+$ ) and neutron ( $n$ ), in the presence of a nucleus at the origin  $O$ . The radius of the nucleus is  $r_0$ . The scale on the  $V$ -axis may not be the same for all figures. The correct pairing of each graph with the corresponding atomic particle is -

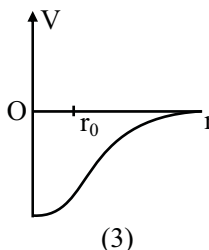
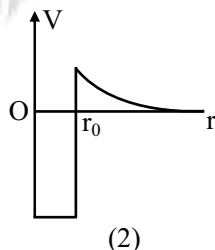
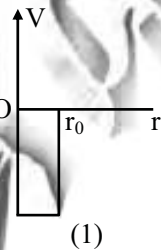

(A) (1,  $n$ ), (2,  $p^+$ ), (3,  $e^-$ )

(C) (1,  $e^-$ ), (2,  $p^+$ ), (3,  $n$ )

(B) (1,  $p^+$ ), (2,  $e^-$ ), (3,  $n$ )

(D) (1,  $p^+$ ), (2,  $n$ ), (3,  $e^-$ )

Ans.

(A)

Sol.

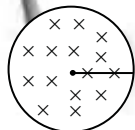

outside the nucleus electric potential decreases

$e^-$  is negativity charged

∴ its PE is negative even outside the nucleus where nuclear attractive force is negligible

(3) → e

outside the nucleus

neutron will not

experience electric force

as it is neutral. So no potential energy associated with it outside nucleus.

1 → neutron

37. Due to transitions among its first three energy levels, hydrogenic atom emits radiation at three discrete wavelengths  $\lambda_1$ ,  $\lambda_2$ , and  $\lambda_3$  ( $\lambda_1 < \lambda_2 < \lambda_3$ ). Then -

- (A)  $\lambda_1 = \lambda_2 + \lambda_3$       (B)  $\lambda_1 + \lambda_2 = \lambda_3$       (C)  $1/\lambda_1 + 1/\lambda_2 = 1/\lambda_3$       (D)  $1/\lambda_1 = 1/\lambda_2 + 1/\lambda_3$

Ans. (D)

Sol.

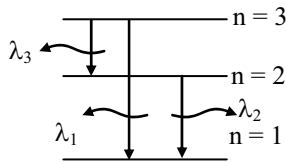

$$\frac{hc}{\lambda_1} = \frac{hc}{\lambda_2} + \frac{hc}{\lambda_3}$$

$$\frac{1}{\lambda_1} = \frac{1}{\lambda_2} + \frac{1}{\lambda_3}$$

38. The total radiative power emitted by spherical blackbody with radius R and temperature T is P. If the radius is doubled and the temperature is halved then the radiative power will be -

- (A) P/4      (B) P/2      (C) 2P      (D) 4P

Ans. (A)

Sol.

$$P = \sigma AT^4$$

$$= \sigma \times 4\pi R^2 \times T^4$$

$$P' = \sigma \times 4\pi (2R)^2 \times \left(\frac{T}{2}\right)^4$$

$$P' = \sigma \times 4\pi R^2 T^4 \times 4 \times \frac{1}{16}$$

$$P' = \frac{P}{4}$$

39. The Quantum Hall Resistance  $R_H$  is a fundamental constant with dimensions of resistance. If h is Planck's constant and e the electron charge, then the dimension of  $R_H$  is the same as -

- (A)  $e^2/h$       (B)  $h/e^2$       (C)  $h^2/e$       (D)  $e/h^2$

Ans. (B)

**Sol.**  $R = \frac{V}{i} = \frac{V \times i}{i^2} = \frac{P}{i^2}$

energy =  $hv = \frac{h}{t}$

Power =  $\frac{\text{energy}}{t}$

$P = \frac{h}{t^2}$

$i = \frac{e}{t}$

$\frac{P}{i^2} = \frac{h}{e^2}$

40. Four students measure the height of a tower. Each student uses a different method and each measures the height many different times. The data for each are plotted below. The measurement with highest precision is

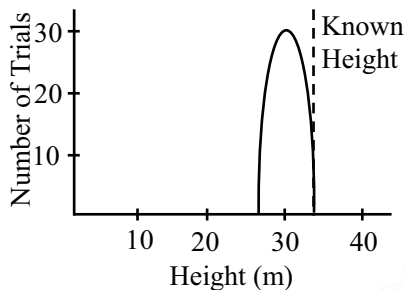

(I)

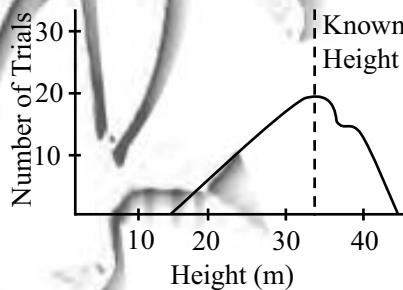

(II)

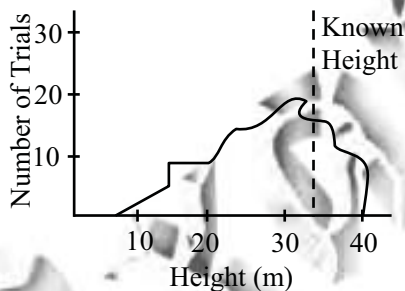

(III)

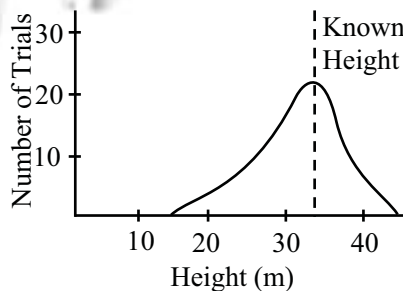

(IV)

(A) I

(B) II

(C) III

(D) IV

**Ans.** (A)

**Sol.** Precision mean every time reading is coming nearly same.



# CHEMISTRY

41. The hybridizations of  $\text{Ni}(\text{CO})_4$  and  $\text{Cr}(\text{H}_2\text{O})_6^{2+}$ , respectively, are  
 (A)  $sp^3$  and  $d^3sp^2$       (B)  $dsp^2$  and  $d^2sp^3$       (C)  $sp^3$  and  $d^2sp^3$       (D)  $dsp^2$  and  $sp^3d^2$

Ans. (C)

Sol.  $\text{Ni}(\text{CO})_4$

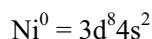

By effect of S.F.L. CO.

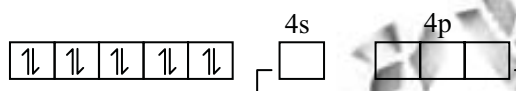

sp<sup>3</sup> Hybri.

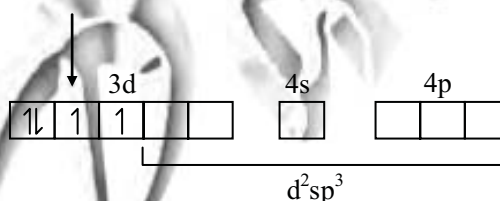

42. Extraction of silver is achieved by initial complexation of the ore (Argentite) with X followed by reduction with Y. X and Y respectively are  
 (A) CN and Zn      (B) CN and Cu      (C) Cl and Zn      (D) Br and Zn

Ans. (A)

Sol. Complexation step

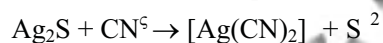

↓ + Zn Reduction step

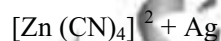

43. Assuming ideal behaviour, the enthalpy and volume of mixing of two liquids, respectively, are  
 (A) zero and zero      (B) +ve and zero      (C) -ve and zero      (D) -ve and -ve

Ans. (A)

Sol. For Ideal Solution

$$\Delta H_{\text{Mix}} = 0 \quad \Delta V_{\text{Mix}} = 0$$

44. At 298 K, the ratio of osmotic pressures of two solutions of a substance with concentrations of 0.01 M and 0.001 M, respectively, is  
 (A) 1      (B) 100      (C) 10      (D) 1000

Ans. (C)

Sol.  $\pi = CRT \Rightarrow \pi \propto C$  at const. T

$$\frac{\pi_1}{\pi_2} = \frac{C_1}{C_2} = \frac{0.01}{0.001} = 10$$

45. The rate of gas phase chemical reactions generally increases rapidly with rise in temperature. This is mainly because
- (A) the collision frequency increases with temperature
  - (B) the fraction of molecules having energy in excess of the activation energy increases with temperature
  - (C) the activation energy decreases with temperature
  - (D) the average kinetic energy of molecules increases with temperature

Ans. (B)

46. Among i-iv

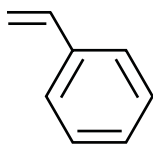

(i)

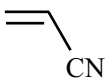

(ii)

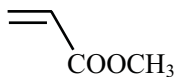

(iii)

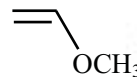

(iv)

the compound that does not undergo polymerization under radical initiation, is

- (A) i
- (B) ii
- (C) iii
- (D) iv

Ans. (D)

Sol.

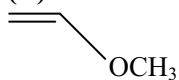

47. Two possible stereoisomers for

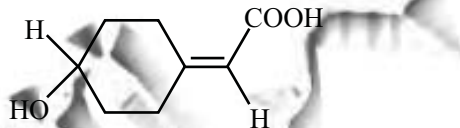

are

- (A) enantiomers
- (B) diastereomers
- (C) conformers
- (D) rotamers

Ans. (A)

Sol.



Chiral  
Carbon

Enantiomers Formed because cyclohexa diene shows optical activity.

48. For a process to occur spontaneously
- (A) only the entropy of the system must increase
  - (B) only the entropy of the surroundings must increase
  - (C) either the entropy of the system or that of the surroundings must increase
  - (D) the total entropy of the system and the surroundings must increase

Ans. (D)

Sol.  $(\Delta S)_{\text{system}} + (\Delta S)_{\text{surrounding}} > 0$  (irreversible process)

49. When the size of a spherical nanoparticle decreases from 30 nm to 10 nm, the ratio surface area/volume becomes  
 (A) 1/3 of the original (B) 3 times the original  
 (C) 1/9 of the original (D) 9 times the original

Ans. (B)

Sol. 
$$\frac{\text{Surface area}}{\text{Volume}} = \frac{\pi d^2}{\frac{\pi d^3}{6}} = \frac{6}{d}$$

$d_1 = 30 \text{ nm}$     $d_2 = 10 \text{ nm}$

$$\left(\frac{\text{Surface area}}{\text{Volume}}\right)_2 = \frac{6}{d_2} = \frac{d_1}{d_2} = \frac{30}{10} = 3$$

$$\left(\frac{\text{Surface area}}{\text{Volume}}\right)_1 = \frac{6}{d_1}$$

50. The major product of the following reaction is :

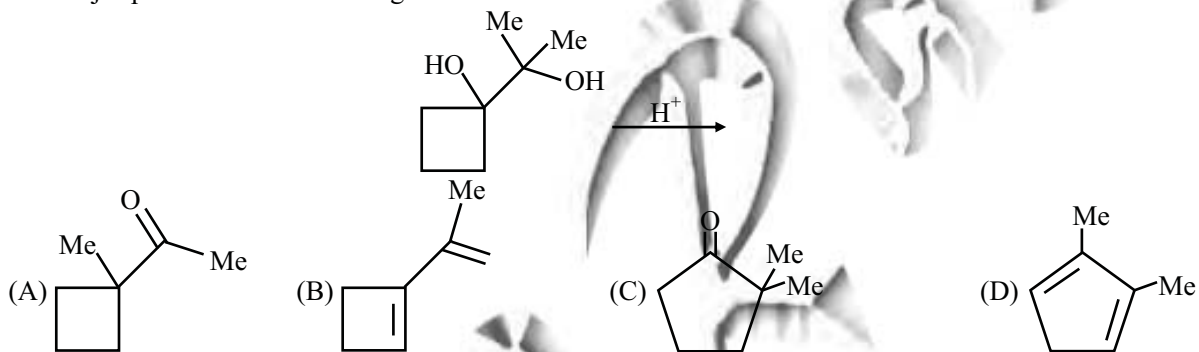

Ans. (C)

Sol.

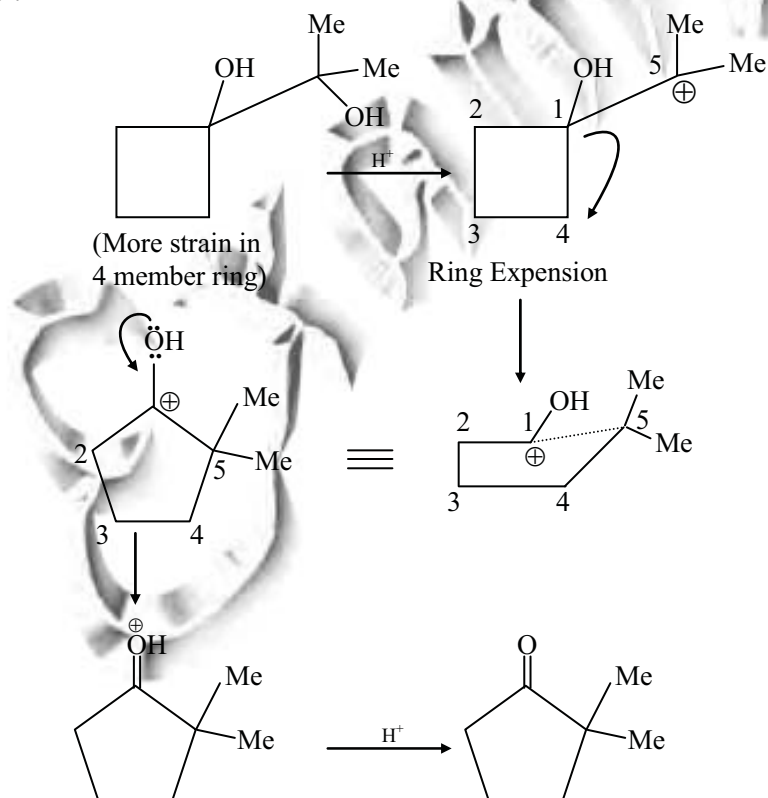

51. For the transformation

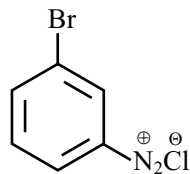

the reagent used is

- (A)  $\text{LiAlH}_4$                       (B)  $\text{H}_3\text{PO}_2$                       (C)  $\text{H}_3\text{O}^+$                       (D)  $\text{H}_2/\text{Pt}$

Ans. (B)

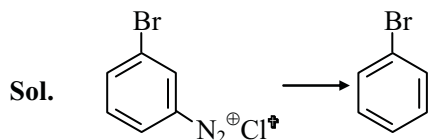

$\text{H}_3\text{PO}_2$  As a reagent used because other are strong reducing agent

52. The value of the limiting molar conductivity ( $\Lambda^\circ$ ) for NaCl, HCl and NaOAc are 126.4, 425.9 and 91.0  $\text{S cm}^2 \text{ mol}^{-1}$ , respectively. For HOAc,  $\Lambda^\circ$  in  $\text{S cm}^2 \text{ mol}^{-1}$  is

- (A) 390.5                      (B) 299.5                      (C) 208.5                      (D) 217.4

Ans. (A)

Sol.  $\Lambda^\circ(\text{HOAc}) = \Lambda^\circ(\text{NaOAc}) + \Lambda^\circ(\text{HCl}) - \Lambda^\circ(\text{NaCl})$   
 $= 91 + 425.9 - 126.4 = 390.5$

53. To obtain a diffraction peak, for a crystalline solid with interplane distance equal to the wavelength of incident X-ray radiation, the angle of incidence should be

- (A)  $90^\circ$                       (B)  $0^\circ$                       (C)  $30^\circ$                       (D)  $60^\circ$

Ans. (C)

Sol. From Bragg's equation

$$n\lambda = 2d \sin\theta$$

$$d = \lambda, n = 1$$

$$1 \times \lambda = 2 \times \lambda \sin\theta$$

$$\sin\theta = \frac{1}{2}$$

$$\theta = 30^\circ$$

54. The standard Gibbs free energy change ( $\Delta G^\circ$  in  $\text{kJ mol}^{-1}$ ), in a Daniel cell ( $E^\circ_{\text{cell}} = 1.1 \text{ V}$ ), when 2 moles of Zn(s) is oxidized at 298 K, is closest to

- (A) -212.3                      (B) -106.2                      (C) -424.6                      (D) -53.1

Ans. (C)

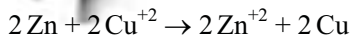
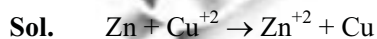

For 2 moles of Zn,  $n = 4$

$$\Delta G^\circ = -nFE^\circ_{\text{cell}} = -4 \times 96500 \times 1.1 = -424.6 \text{ kJ}$$

55. All the products formed in the oxidation of  $\text{NaBH}_4$  by  $\text{I}_2$ , are  
 (A)  $\text{B}_2\text{H}_6$  and  $\text{NaI}$  (B)  $\text{B}_2\text{H}_6$ ,  $\text{H}_2$  and  $\text{NaI}$  (C)  $\text{BI}_3$  and  $\text{NaH}$  (D)  $\text{NaBI}_4$  and  $\text{HI}$

Ans. (B)

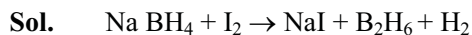

56. The spin-only magnetic moments of  $[\text{Mn}(\text{CN})_6]^{4-}$  and  $[\text{MnBr}_4]^{2-}$  in Bohr Magnetons, respectively, are  
 (A) 5.92 and 5.92 (B) 4.89 and 1.73 (C) 1.73 and 5.92 (D) 1.73 and 1.73

Ans. (C)

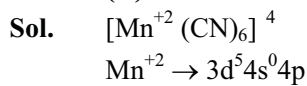

CN is strong ligands so creates back pairing effect of  $(n-1)$  d orbitals configuration

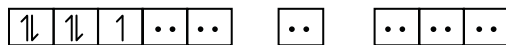

So, unpaired  $e = 1$

$$\mu = \sqrt{n(n+2)} \text{ B.M}$$

$$\mu = 1.73 \text{ B.M}$$

And in  $[\text{MnBr}_4]^{2-}$

Br is a weak ligands so no back pairing effect on  $(n-1)$  d orbital so, unpaired  $e = 5$

$$\mu = \sqrt{5(5+2)} = \sqrt{35} = 5.92 \text{ B.M}$$

57. In a zero-order reaction, if the initial concentration of the reactant is doubled, the time required for half the reactant to be consumed  
 (A) increases two-fold (B) increases four-fold (C) decreases by half (D) does not change

Ans. (A)

Sol.  $K = \frac{A_0 - A_t}{t}$

$$K = \frac{A_2}{2t_{1/2}}$$

$$t_{1/2} = \frac{A_0}{2K} \text{ Zero order}$$

$t_{1/2} \propto \text{initial concentration}$   
 so double times

58. The adsorption isotherm for a gas is given by the relation  $x = \frac{ap}{1+bp}$  where  $x$  is moles of gas adsorbed per gram of the adsorbent,  $p$  is the pressure of the gas, and  $a$  and  $b$  are constants. Then  $x$   
 (A) increases with  $p$   
 (B) remains unchanged with  $p$   
 (C) decreases with  $p$   
 (D) increases with  $p$  at low pressures and then remains the same at high pressure

Ans. (D)

Sol. According to Lagmuir curve

$$x = \frac{ap}{1+bp}$$

$$p \rightarrow \infty \quad x = \frac{a}{b}$$

$$p \rightarrow 0 \quad x \propto p$$

59. The reaction

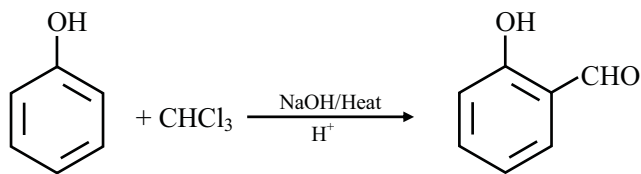

is known as

(A) Perkin reaction

(B) Sandmeyer reaction

(C) Reimer-Tiemann reaction

(D) Cannizzaro reaction

Ans. (C)

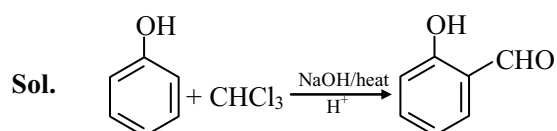

Reimer – Tiemann Reaction – Phenol react with  $\text{CHCl}_3$  in presence of NaOH given product

60. Among i-iii

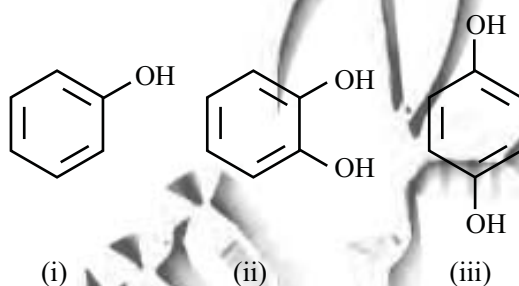

the boiling point follows the order

(A)  $\text{ii} < \text{i} < \text{iii}$

(B)  $\text{iii} < \text{ii} < \text{i}$

(C)  $\text{i} < \text{ii} < \text{iii}$

(D)  $\text{ii} < \text{iii} < \text{i}$

Ans. (C)

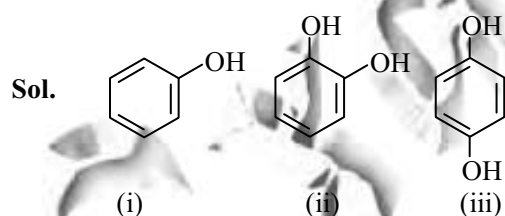

$\text{(iii)} > \text{(ii)} > \text{(i)}$

In (ii) Intra H-Bonding is not formed because ring formation is not stable

# BIOLOGY

61. The major constituents of neurofilaments are-

- (A) microtubules (B) intermediate filaments  
(C) actin filaments (D) protofilaments

Ans. (D)

62. In which phase of the cell cycle are sister chromatids available as template for repair ?

- (A) G1 phase (B) G2 phase (C) S phase (D) M phase

Ans. (D)

Sol. Because in M phase sister chromatid form.

63. A person has difficulty in breathing at higher altitudes because-

- (A) oxygen is likely to diffuse from lungs to blood  
(B) oxygen is likely to diffuse from blood to lungs  
(C) partial pressure of O<sub>2</sub> is lower than partial pressure of CO<sub>2</sub>  
(D) overall intake of O<sub>2</sub> by the blood becomes low

Ans. (C)

64. In humans, the composition of a zygote that will develop into a female is-

- (A) 44 A + XX (B) 44 A + XY (C) 22 + X (D) 23 A

Ans. (A)

65. If you fractionate all the organelles from the cytoplasm of a plant cell, in which one of the following sets of fractions will you find nucleic acids ?

- (A) nucleus, mitochondria, chloroplast, cytoplasm  
(B) nucleus, mitochondria, chloroplast, glyoxysome  
(C) nucleus, chloroplast, cytoplasm and peroxisome  
(D) nucleus, mitochondria, chloroplast, Golgi bodies

Ans. (A)

66. A protein with 100 amino acid residues has been translated based on triplet genetic code. Had the genetic code been quadruplet, the gene that codes for the protein would have been-

- (A) same in size  
(B) longer in size by 25 %  
(C) longer in size by 100 %  
(D) shorter in size

Ans. (B)

67. If the sequence of bases in DNA is 5'-ATGTATCTCAAT-3', then the sequence of bases in its transcript will be-

- (A) 5'-TACATAGAGTTA-3' (B) 5'-UACAUAGAGUUA-3'  
(C) 5'-AUGUAUCUCAAU-3' (D) 5'-AUUGAGAUACAU-3'

Ans. (D)

68. The  $\text{Na}^+/\text{K}^+$  pump is present in the plasma membrane of mammalian cells where it-
- (A) expels potassium from the cell
  - (B) expels sodium and potassium from the cell
  - (C) pumps sodium into the cell
  - (D) expels sodium from the cell

Ans. (D)

69. The  $\text{CO}_2$  in the blood is mostly carried-
- (A) by hemoglobin in RBCs
  - (B) in the cytoplasm of WBCs
  - (C) in the plasma as bicarbonate ions
  - (D) by plasma proteins

Ans. (C)

70. Patients who have undergone organ transplants are given anti-rejection medications to-
- (A) minimize infection
  - (B) stimulate B-macrophage cell interaction
  - (C) prevent T-lymphocyte proliferation
  - (D) adopt the HLA of donor

Ans. (C)

71. Saline drip is given to a Cholera patient because-
- (A)  $\text{NaCl}$  kills *Vibrio cholera*
  - (B)  $\text{NaCl}$  generates ATP
  - (C)  $\text{Na}^+$  ions stops nerve impulse and hence sensation of pain
  - (D)  $\text{Na}^+$  ions help in retention of water in body tissue

Ans. (D)

72. A water molecule can form a maximum of ..... hydrogen bonds.

(A) 1 (B) 2 (C) 3 (D) 4

Ans. (D)

73. Circadian Rhythm is an endogenously driven cycle for biochemical, physiological and behavioral processes. In humans, the approximate duration of this 'biological clock' is-

(A) 1 Hour (B) 6 Hours (C) 12 Hours (D) 24 Hours

Ans. (D)

74. Modern evolutionary theory consists of the concepts of Darwin modified by knowledge concerning-
- (A) population statistics
  - (B) Mendel's laws
  - (C) the idea of the survival of the fittest
  - (D) competition

Ans. (C)

Sol. Propounded by Herbert Spencer for natural selection process. This explains that adaptability has the genetic basis which proves fitness of an organism and nature selects organism for its fitness and allow to produce its progeny in large number.



75. Soon after the three germ layers are formed in a developing embryo, the process of organogenesis starts. The human brain is formed from the-
- (A) ectoderm
  - (B) endoderm
  - (C) mesoderm
  - (D) partly endoderm and partly mesoderm

**Ans. (A)**

**Sol.** Organogenesis begins with the process of neurulation. This neurulation begins with the formation of primitive streak in epiblast (Ectoderm) which leads to formation of neural tube (nerve cord)

76. Puffs in the polytene chromosomes of *Drosophila melanogaster* salivary glands represent-
- (A) transcriptionally active genes
  - (B) transcriptionally inactive genes
  - (C) heterochromatin
  - (D) housekeeping genes

**Ans. (A)**

77. The process of cell death involving DNA cleavage in cells is known as-
- (A) necrosis
  - (B) apoptosis
  - (C) cytokinesis
  - (D) endocytosis

**Ans. (B)**

78. According to the original model of DNA, as proposed by Watson & Crick in 1953, DNA is a-
- (A) left handed helix
  - (B) helix that makes a full turn every 70 nm
  - (C) helix where one turn of DNA contains 20 basepairs
  - (D) two stranded helix where each strand has opposite polarity

**Ans. (D)**

79. At which stage of Meiosis I does crossing over occur ?
- (A) leptotene
  - (B) zygotene
  - (C) pachytene
  - (D) diplotene

**Ans. (C)**

80. An electrode is placed in the axoplasm of a mammalian axon and another electrode is placed just outside the axon. The potential difference measured will be-

- (A) 0
- (B) -70 mV
- (C) -70  $\mu$ V
- (D) +70  $\mu$ V

**Ans. (B)**

**PART -2**  
**Two-Marks Question**  
**MATHEMATICS**

- 81.** Let A and B be any two  $n \times n$  matrices such that the following conditions hold :  $AB = BA$  and there exist positive integers k and  $\ell$  such that  $A^k = I$  (the identity matrix) and  $B^\ell = 0$  (the zero matrix). Then-
- (A)  $A + B = I$  (B)  $\det(AB) = 0$   
 (C)  $\det(A + B) \neq 0$  (D)  $(A + B)^m = 0$  for some integer m

**Ans.** (B)

**Sol.**  $A^k = I, B^\ell = 0$  ( $\det(B) = 0$ )  
 $\Rightarrow \det(AB) = 0$

- 82.** The minimum value of n for which  $\frac{2^2 + 4^2 + 6^2 + \dots + (2n)^2}{1^2 + 3^2 + 5^2 + \dots + (2n-1)^2} < 1.01$
- (A) is 101 (B) is 121 (C) is 151 (D) does not exist

**Ans.** (C)

**Sol.**  $\frac{x}{\frac{2n(2n+1)(4n+1)}{6} - x} < 1.01$

$$2.01x < (1.01) \frac{2n(2n+1)(4n+1)}{6}$$

$$2.01 \cdot \frac{4n(n+1)(2n+1)}{6} < (1.01) \frac{2n(2n+1)(4n+1)}{6}$$

$$\frac{2.01}{1.01} < \frac{4n+1}{2n+2} \Rightarrow n > 150.5$$

- 83.** The locus of the point P = (a, b) where a, b are real numbers such that the roots of  $x^3 + ax^2 + bx + a = 0$  are in arithmetic progression is-

- (A) an ellipse  
 (B) a circle  
 (C) a parabola whose vertex in on the y-axis  
 (D) a parabola whose vertex is on the x-axis

**Ans.** (C)

**Sol.** Let roots  $\alpha-d, \alpha, \alpha+d$  product  
 Sum  $3\alpha = -a \Rightarrow \alpha = -\frac{a}{3}$   $\alpha(\alpha^2 - d^2) = -a$   
 pair product  $b = \alpha^2 - \alpha d + \alpha^2 + \alpha d + \alpha^2 - d^2$   $\alpha^2 - d^2 = 3$   
 $b = 2\alpha^2 + 3$   
 $b - 3 = \frac{2}{9} a^2 \Rightarrow \text{locus } x^2 = \frac{9}{2}(y - 3)$  parabola

84. The smallest possible positive slope of a line whose y-intercept is 5 and which has a common point with the ellipse  $9x^2 + 16y^2 = 144$  is-

- (A)  $\frac{3}{4}$  (B) 1 (C)  $\frac{4}{3}$  (D)  $\frac{9}{16}$

Ans. (B)

Sol. ellipse  $\frac{x^2}{16} + \frac{y^2}{9} = 1$

$$\text{Any tangent } \frac{x \cos \theta}{4} + \frac{y \sin \theta}{3} = 1$$

$$y \text{ intercept} = 5 \Rightarrow \sin \theta = \frac{3}{5} ; \theta \in \left( \frac{\pi}{2}, \pi \right)$$

$$\Rightarrow \cos \theta = -\frac{4}{5}$$

$$\text{tangent} \Rightarrow -\frac{x}{5} + \frac{y}{5} = 1 \Rightarrow \text{slope} = 1$$

85. Let  $A = \{\theta \in \mathbb{R} \mid \cos^2(\sin \theta) + \sin^2(\cos \theta) = 1\}$  and  $B = \{\theta \in \mathbb{R} \mid \cos(\sin \theta) \sin(\cos \theta) = 0\}$ . Then  $A \cap B$

- (A) is the empty set  
 (B) has exactly one element  
 (C) has more than one but finitely many elements  
 (D) has infinitely many elements

Ans. (A)

Sol. for  $A \cap B$

$$\cos(\sin \theta) = 1 \text{ or } -1 \text{ \& } \sin(\cos \theta) = 0$$

which is not possible

$$\text{or } \cos(\sin \theta) = 0 \text{ \& } \sin(\cos \theta) = 1 \text{ or } -1$$

also not possible

so  $A \cap B$  is an empty set

86. Let  $f(x) = x^3 + ax^2 + bx + c$ , where  $a, b, c$  are real numbers. If  $f(x)$  has a local minimum at  $x = 1$  and a local

maximum at  $x = -\frac{1}{3}$  and  $f(2) = 0$ , then  $\int_{-1}^1 f(x) dx$  equals-

- (A)  $\frac{14}{3}$  (B)  $-\frac{14}{3}$  (C)  $\frac{7}{3}$  (D)  $-\frac{7}{3}$

Ans. (B)

Sol.  $f'(x) = 3\left(x^2 - \frac{2}{3}x - \frac{1}{3}\right) = 3x^2 - 2x - 1$

$$f(x) = x^3 - x^2 - x + \lambda$$

$$f(2) = 8 - 4 - 2 + \lambda = 0 \Rightarrow \lambda = -2$$

$$f(x) = x^3 - x^2 - x - 2$$

$$\int_{-1}^1 f(x) dx = -2 \int_{-1}^1 (x^2 + 2) dx = -2 \left( \frac{1}{3} + 2 \right) = -\frac{14}{3}$$

87. Let  $f(x) = x^{12} - x^9 + x^4 - x + 1$ . Which of the following is true ?  
 (A)  $f$  is one-one  
 (B)  $f$  has a real root  
 (C)  $f'$  never vanishes  
 (D)  $f$  takes only positive values

Ans. (D)

Sol.  $f(x) = x^9(x^3 - 1) + x(x^3 - 1) + 1$  positive for  $x \geq 1$  or  $x \leq 0$   
 $= 1 - x + x^4 - x^9 + x^{12}$  positive for  $x \in (0, 1)$   
 $f(x)$  is always positive

88. For each positive integer  $n$ , define  $f_n(x) = \text{minimum} \left( \frac{x^n}{n!}, \frac{(1-x)^n}{n!} \right)$ , for  $0 \leq x \leq 1$ . Let  $I_n = \int_0^1 f_n(x) dx, n \geq 1$ .

Then  $I_n = \sum_{n=1}^{\infty} I_n$  is equal to-

- (A)  $2\sqrt{e} - 3$  (B)  $2\sqrt{e} - 2$   
 (C)  $2\sqrt{e} - 1$  (D)  $2\sqrt{e}$

Ans. (A)

Sol.  $I_n = \int_0^{1/2} \frac{x^n}{n!} dx + \int_{1/2}^1 \frac{(1-x)^n}{n!} dx = \frac{1}{(n+1)!} \left( \left( \frac{1}{2} \right)^{n+1} + \left( \frac{1}{2} \right)^{n+1} \right) = \frac{\left( \frac{1}{2} \right)^n}{(n+1)!}$   
 $\sum_{n=1}^{\infty} I_n = \left( \frac{1/2}{2!} + \frac{(1/2)^2}{3!} + \dots \right) = 2\sqrt{e} - 3$

89. The maximum possible value of  $x^2 + y^2 - 4x - 6y$ ,  $x, y$  real, subject to the condition  $|x + y| + |x - y| = 4$   
 (A) is 12 (B) is 28 (C) is 72 (D) does not exist

Ans. (B)

Sol.

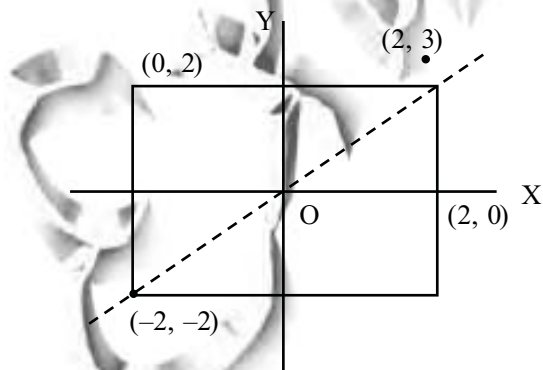

$|x + y| + |x - y| = 4$  represent a square  
 $x^2 + y^2 - 4x - 6y = (x - 2)^2 + (y - 3)^2 - 13$   
 $= (\text{distance point on square from } (2, 3))^2 - 13$   
 Maximum  $= (-2 - 2)^2 + (-2 - 3)^2 - 13 = 28$

90. The arithmetic mean and the geometric mean of two distinct 2-digit numbers  $x$  and  $y$  are two integers one of which can be obtained by reversing the digits of the other (in base 10 representation). Then  $x + y$  equals-
- (A) 82                                      (B) 116                                      (C) 130                                      (D) 148

Ans. (C)

Sol.  $\frac{x+y}{2} = 10a + b, \sqrt{xy} = 10b + a \quad (a, b \in \mathbb{N})$

$$xy = (10b + a)^2$$

$$(x - y)^2 = 4(11a + 11b)(9a - 9b)$$

$$= 4 \cdot 11 \cdot (a + b) \cdot 9(a - b)$$

$$\Rightarrow a + b = 11, a - b = 1$$

$$a = 6, b = 5$$

$(x - y)^2$  is perfect square of an integer

$$x + y = 130$$

## PHYSICS

91. An isolated sphere of radius  $R$  contains uniform volume distribution of positive charge. Which of the curves shown below correctly illustrates the dependence of the magnitude of the electric field of the sphere as a function of the distance  $r$  from its centre ?

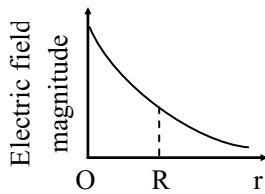

(I)

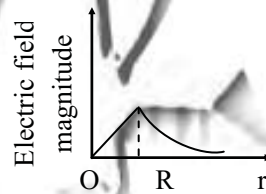

(II)

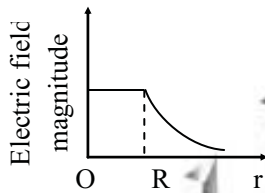

(III)

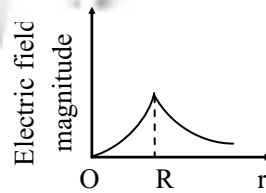

(IV)

(A) I

(B) II

(C) III

(D) IV

Ans. (B)

Sol. When  $r < R$                                        $E = \frac{\rho r}{3\epsilon_0}$

When  $r > R$                                        $E = \frac{Q}{4\pi\epsilon_0 r^2}$

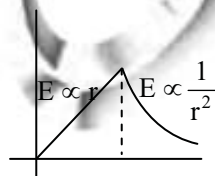

92. The surface of a planet is found to be uniformly charged. When a particle of mass  $m$  and no charge is thrown at an angle from the surface of the planet, it has a parabolic trajectory as in projectile motion with horizontal range  $L$ . A particle of mass  $m$  and charge  $q$ , with the same initial conditions has a range  $L/2$ . The range of particle of mass  $m$  and charge  $2q$  with the same initial conditions is-
- (A)  $L$                       (B)  $L/2$                       (C)  $L/3$                       (D)  $L/4$

Ans. (C)

Sol. For uncharged particle

$$L = \frac{u^2 \sin 2\theta}{g} \quad \dots (i)$$

Range for particle of mass  $m$  and charge  $q$ .

$$\frac{L}{2} = \frac{u^2 \sin 2\theta}{g + \frac{qE}{m}} \quad \dots (ii)$$

From (i) and (ii)

$$\frac{u^2 \sin 2\theta}{2g} = \frac{u^2 \sin 2\theta}{g + \frac{qE}{m}}$$

$$\Rightarrow mg = qE$$

Range of particle of mass  $m$  & charge  $2q$ .

$$R = \frac{u^2 \sin 2\theta}{g + \frac{2qE}{m}} = \frac{u^2 \sin 2\theta}{g \left( 1 + \frac{2qE}{mg} \right)} = \frac{L}{3}$$

93. Figure below shows a small mass connected to a string, which is attached to a vertical post. If the ball is released when the string is horizontal as shown, the magnitude of the total acceleration (including radial and tangential) of the mass as a function of the angle  $\theta$  is-

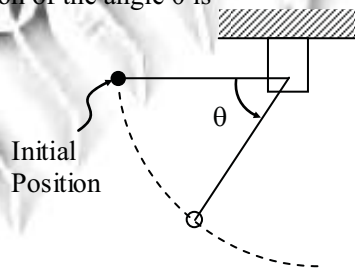

(A)  $g \sin \theta$

(B)  $g\sqrt{3 \cos^2 \theta + 1}$

(C)  $g \cos \theta$

(D)  $g\sqrt{3 \sin^2 \theta + 1}$

Ans. (D)

Sol.

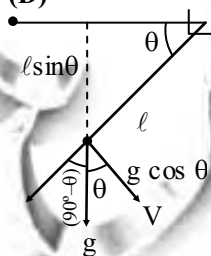

$$\text{Radical acceleration} = \frac{V^2}{R} = \frac{2g\ell \sin \theta}{\ell} = 2 g \sin \theta$$

$$\text{tangential acceleration} = g \cos \theta$$

$$\text{total acceleration} = \sqrt{4g^2 \sin^2 \theta + g^2 \cos^2 \theta} \Rightarrow g\sqrt{1 + 3 \sin^2 \theta}$$

94. One mole of an ideal gas at initial temperature  $T$ , undergoes a quasi-static process during which the volume  $V$  is doubled. During the process the internal energy  $U$  obeys the equation  $U = aV^3$ , where  $a$  is a constant. The work done during this process is-
- (A)  $3RT/2$                       (B)  $5RT/2$                       (C)  $5RT/3$                       (D)  $7RT/3$

Ans. (D)

Sol.  $U = aV^3$

$$\frac{f n R T}{2} = aV^3$$

$$PV = RT$$

$$\frac{PV}{R} = aV^3$$

$$P = CV^2$$

$$W = \int_v^{2v} P dV = \int_v^{2v} CV^2 dV = \frac{C}{3}(8V^3 - V^3) = \frac{7V^3 C}{3}$$

$$\frac{fRT}{2} = aV^3$$

$$PV = RT$$

$$\frac{fPV}{2} = aV^3$$

$$P = \frac{2a}{f} V^2$$

$$C = \frac{2a}{f}$$

$$W = \frac{7}{3} \times V^3 \times \frac{2a}{f} = \frac{7}{3f} f n R T = \frac{7RT}{3}$$

95. A constant amount of an ideal gas undergoes the cyclic process ABCA in the PV diagram shown below

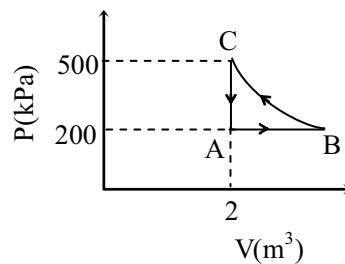

The path BC is an isothermal. The work done by the gas during one complete cycle, beginning and ending at A, is nearly-

- (A) 600 kJ                      (B) 300 kJ  
(C) -300 kJ                      (D) -600 kJ

Ans. (C)

Sol.

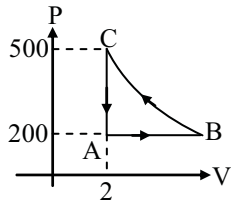

$$W_{C \rightarrow A} = 0$$

Process BC  $T = \text{Constant}$

$$P_C V_C = P_B V_B$$

$$500 \times 2 = 200 \times V_B$$

$$V_B = 5 \text{ m}^3$$

$$W_{A \rightarrow B} = 200 [V_B - V_A] = 200 [5 - 2] \\ = 600$$

$$W_{B \rightarrow C} > W_{A \rightarrow B}$$

$\therefore$  Net work done is -ve

$$\therefore W_{B \rightarrow C} < 1200 \text{ KJ}$$

$$\therefore \text{Total } W < -600 \text{ KJ}$$

96. A material is embedded between two glass plates. Refractive index  $n$  of the material varies with thickness as shown below. The maximum incident angle (in degrees) on the material for which beam will pass through the material is-

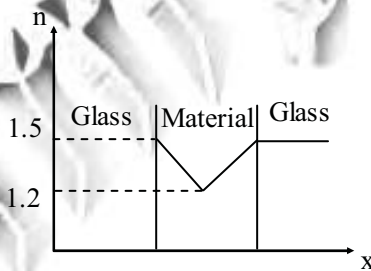

(A) 60.0

(B) 53.1

(C) 43.5

(D) 32.3

Ans. (B)

Sol.  $1.5 \times \sin i = 1.2 \sin r$

$$\sin r = \frac{1.5}{1.2} \sin i$$

T/R should not take place

$$\therefore \sin r < 1$$

$$\frac{1.5}{1.2} \sin i < 1$$

$$\sin i < \frac{12}{15}$$

$$\sin i < 0.8$$

$$\sin 45 = \frac{1}{\sqrt{2}} = 0.707$$

$$i_{\max} > 45$$

97. At a distance  $\ell$  from a uniformly charged long wire, a charged particle is thrown radially outward with a



velocity  $u$  in the direction perpendicular to the wire. When the particle reaches a distance  $2\ell$  from the wire its speed is found to be  $\sqrt{2}u$ . The magnitude of the velocity, when it is a distance  $4\ell$  away from the wire, is (ignore gravity)

- (A)  $\sqrt{3}u$                       (B)  $2u$                       (C)  $2\sqrt{2}u$                       (D)  $4u$

Ans. (A)

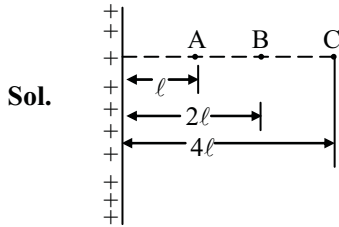

energy conservation at A & B

$$qV_A + \frac{1}{2} mu^2 = qV_B + \frac{1}{2} m \times 2u^2$$

$$q [V_A - V_B] = \frac{1}{2} mu^2$$

$$q \times \frac{\lambda}{2\pi\epsilon_0} \ln 2 = \frac{1}{2} mu^2$$

energy conservation at A & C

$$qV_A + \frac{1}{2} mu^2 = qV_C + \frac{1}{2} mv^2$$

$$q [V_A - V_C] + \frac{1}{2} mu^2 = \frac{1}{2} mv^2$$

$$\frac{q\lambda}{2\pi\epsilon_0} \ln 4 + \frac{1}{2} mu^2 = \frac{1}{2} mv^2$$

$$\frac{2q\lambda}{2\pi\epsilon_0} \ln 2 + \frac{1}{2} mu^2 = \frac{1}{2} mv^2$$

$$mu^2 + \frac{1}{2} mu^2 = \frac{1}{2} mv^2$$

$$\frac{3}{2} u^2 = \frac{1}{2} v^2 \Rightarrow v = \sqrt{3} u$$

98. A rectangular loop of wire shown below is coplanar with a long wire carrying current  $I$ .

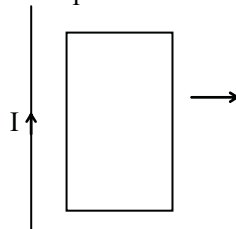

The loop is pulled to the right as indicated. What are the directions of the induced current in the loop and the magnetic forces on the left and the right sides of the loop ?

- |     | <b>Induced current</b> | <b>Force on left side</b> | <b>Force on right side</b> |
|-----|------------------------|---------------------------|----------------------------|
| (A) | Counterclockwise       | To the left               | To the right               |
| (B) | Clockwise              | To the left               | To the right               |
| (C) | Counterclockwise       | To the right              | To the left                |
| (D) | Clockwise              | To the right              | To the left                |

Ans. (B)

**Sol.** Flux is inward and it is decreasing as loop is going away from wire

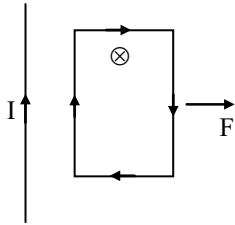

∴ direction of induced current is clockwise

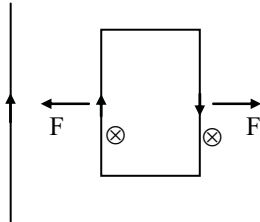

Force on left side is in left and force on right side is in right.

**99.** Two batteries  $V_1$  and  $V_2$  are connected to three resistors as shown below.

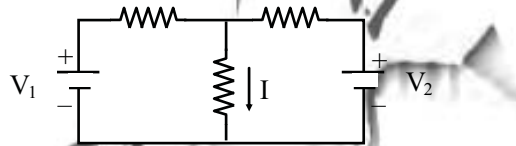

If  $V_1 = 2V$  and  $V_2 = 0V$ , the current  $I = 3\text{ mA}$ . If  $V_1 = 0V$  and  $V_2 = 4V$ , the current  $I = 4\text{ mA}$ . Now, if  $V_1 = 10V$  and  $V_2 = 10V$ , the current  $I$  will be-

- (A) 7 mA                      (B) 15 mA                      (C) 20 mA                      (D) 25 mA

**Ans.** (D)

**Sol.**

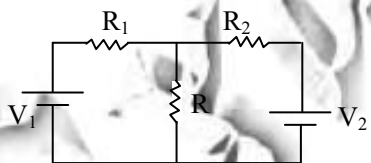

$$V_{eq} = \frac{\frac{V_1}{R_1} + \frac{V_2}{R_2}}{\frac{1}{R_1} + \frac{1}{R_2}} \Rightarrow \frac{V_1 R_2 + V_2 R_1}{R_1 + R_2}; R_{eq} = \frac{R_1 R_2}{R_1 + R_2}$$

$$I = \frac{V_{eq}}{R + R_{eq}}$$

In each case  $R_{eq}$  &  $R$  is same only  $V_1$  &  $V_2$  is changing ∴  $V_{eq}$  is changing

C

ase - 1

$$V_{eq} = \frac{2 \times R_2 + 0 \times R_1}{R_1 + R_2} \quad [V_1 = 2, V_2 = 0]$$

$$V_{eq} = \frac{2R_2}{R_1 + R_2}$$

**Case - 2**  $V_{eq} = \frac{4R_1}{R_1 + R_2} \quad [V_1 = 0, V_2 = 4]$

$$\frac{I_1}{I_2} = \frac{3}{4} = \frac{2R_2}{4R_1} \quad \frac{R_2}{R_1} = \frac{3}{2}$$

**Case - 3**  $V_{eq} = \frac{10R_1 + 10R_2}{R_1 + R_2}$

$$\frac{3}{I'} = \frac{2R_2}{10(R_1 + R_2)} \Rightarrow \frac{3}{I'} = \frac{2 \times 1.5R_1}{10(2.5R_1)} \text{ or } I' = 25 \text{ mA}$$

- 100.** A particle moves in a plane along an elliptic path given by  $\frac{x^2}{a^2} + \frac{y^2}{b^2} = 1$ . At point (0, b), the x-component of velocity is u. The y-component of acceleration at this point is-
- (A)  $-bu^2/a^2$                       (B)  $-u^2/b$                       (C)  $-au^2/b^2$                       (D)  $-u^2/a$

**Ans. (A)**

**Sol.**  $\frac{x^2}{a^2} + \frac{y^2}{b^2} = 1$

$$u_x = u \text{ at } (0, b)$$

$$u_y = 0$$

$$\frac{2x}{a^2} \frac{dx}{dt} + \frac{2y}{b^2} \frac{dy}{dt} = 0$$

Again diff. w.r.t. to time

$$\frac{2x}{a^2} \frac{d^2x}{dt^2} + \frac{2}{a^2} \left(\frac{dx}{dt}\right)^2 + \frac{2y}{b^2} \frac{d^2y}{dt^2} + \frac{2}{b^2} \left(\frac{dy}{dt}\right)^2 = 0$$

acceleration at (0, b) is

$$a_y = \frac{-b}{a^2} u^2$$

## CHEMISTRY

- 101.**  $\text{XeF}_6$  hydrolyses to give an oxide. The structure of  $\text{XeF}_6$  and the oxide, respectively, are-
- (A) octahedral and tetrahedral  
 (B) distorted octahedral and pyramidal  
 (C) octahedral and pyramidal  
 (D) distorted octahedral and tetrahedral

**Ans. (B)**

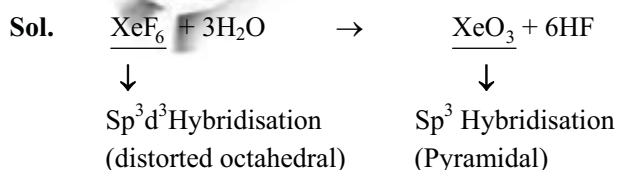

102.  $\text{MnO}_4^-$  oxidizes (i) oxalate ion in acidic medium at 333 K and (ii) HCl. For balanced chemical equations, the ratios  $[\text{MnO}_4^- : \text{C}_2\text{O}_4^{2-}]$  in (i) and  $[\text{MnO}_4^- : \text{HCl}]$  in (ii), respectively, are-
- (A) 1 : 5 and 2 : 5      (B) 2 : 5 and 1 : 8      (C) 2 : 5 and 1 : 5      (D) 5 : 2 and 1 : 8

Ans. (B)

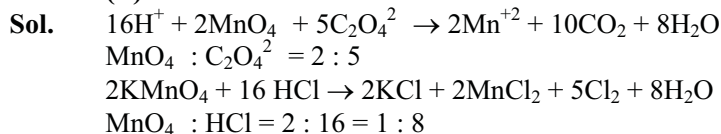

103. If  $E^\circ_{\text{Fe}^{2+}/\text{Fe}} = -0.440\text{ V}$  and  $E^\circ_{\text{Fe}^{3+}/\text{Fe}^{2+}} = 0.770\text{ V}$ , then  $E^\circ_{\text{Fe}^{3+}/\text{Fe}}$  is-

- (A) 0.330 V      (B) -0.037 V      (C) -0.330 V      (D) -1.210 V

Ans. (B)

Sol.  $\text{Fe}^{3+}/\text{Fe}$

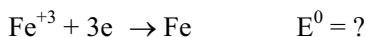
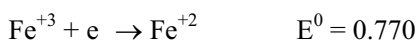

$$E^\circ = \frac{n_1 E_1^\circ + n_2 E_2^\circ}{n_3} = \frac{2(-0.44) + 1 \times (0.770)}{3} = \frac{-0.88 + 0.770}{3} = -0.037 \text{ volt}$$

104. The electron in hydrogen atom is in the first Bohr orbit ( $n = 1$ ). The ratio of transition energies,  $E(n = 1 \rightarrow n = 3)$  to  $E(n = 1 \rightarrow n = 2)$ , is-

- (A) 32/27      (B) 16/27      (C) 32/9      (D) 8/9

Ans. (A)

Sol.  $\Delta E = 13.6 \left( \frac{1}{n_1^2} - \frac{1}{n_2^2} \right) \text{ eV/atom}$  ;  $\frac{\Delta E_{1 \rightarrow 3}}{\Delta E_{1 \rightarrow 2}} = \frac{\frac{1}{1^2} - \frac{1}{3^2}}{\frac{1}{1^2} - \frac{1}{2^2}} = \frac{.32}{.25} = \frac{32}{25}$

105. In the following conversion,

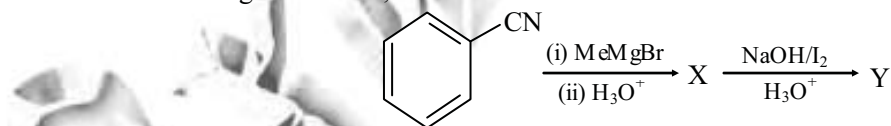

the major products X and Y, respectively, are-

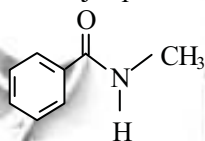

and

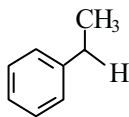

(i)

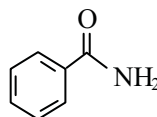

and

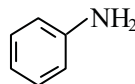

(ii)

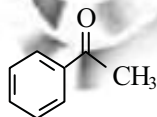

and

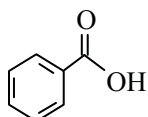

(iii)

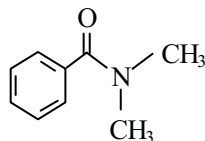

and

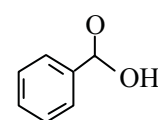

(iv)

(A) i

(B) ii

(C) iii

(D) iv

Ans. (C)

Sol.

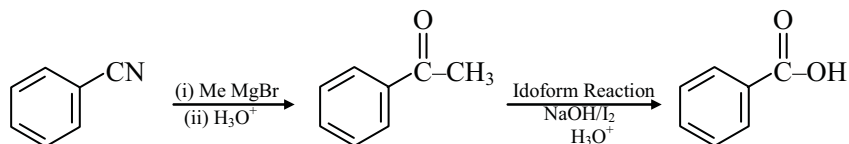

106. In the reaction sequence,

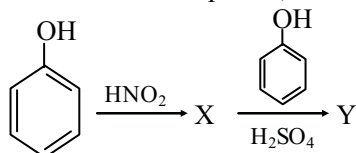

the major products X and Y, respectively, are-

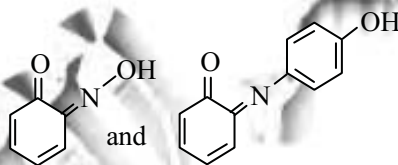
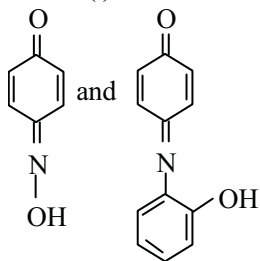
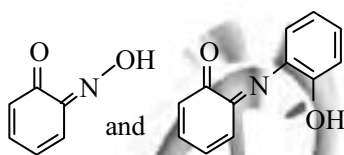
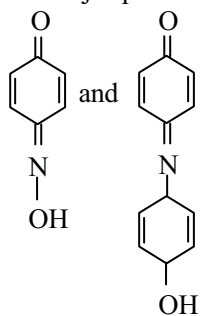

(A) i

(B) ii

(C) iii

(D) iv

Ans.

(C)

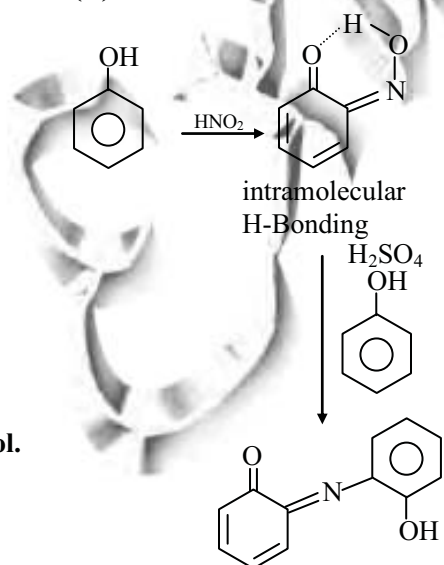

Sol.

107. Optically active (S)- $\alpha$ -methoxyacetaldehyde on reaction with MeMgX gave a mixture of alcohols. The

major diastereomer 'P' on treatment with MeI/K<sub>2</sub>CO<sub>3</sub> gave an optically inactive compound. P is-

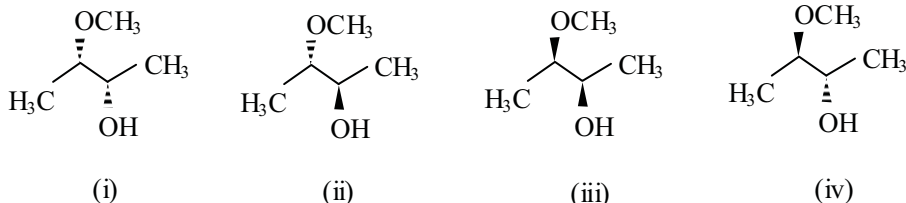

- (A) i (B) ii (C) iii (D) iv

Ans.

Sol. Incorrect question

The statement optically active (s) -  $\alpha$  - methoxy acetaldehyde is incorrect.

108. At 300 K the vapour pressure of two pure liquids, A and B are 100 and 500 mm Hg, respectively. If in a mixture of A and B, the vapour pressure is 300 mm Hg, the mole fractions of A in the liquid and in the vapour phase, respectively, are-

- (A) 1/2 and 1/10 (B) 1/4 and 1/6 (C) 1/4 and 1/10 (D) 1/2 and 1/6

Ans. (D)

Sol.

$$Y_A = \frac{P_A^0 X_A}{P_A^0 X_A + P_B^0 X_B} = \frac{100 \cdot \frac{1}{2}}{100 \cdot \frac{1}{2} + 500 \cdot \frac{1}{2}}$$

$$= \frac{50}{50 + 250}$$

$$= \frac{50}{300}$$

$$= 1/6$$

$$\therefore P_s = (p_A^0 - p_B^0) X_A + p_B^0$$

$$300 = (-400) X_A + 500$$

$$X_A = \frac{1}{2}$$

$$\therefore X_B = \frac{1}{2}$$

109. The crystal field stabilization energies (CFSE) of high spin and low spin d<sup>6</sup> metal complexes in terms of  $\Delta_0$ , respectively, are-

- (A) -0.4 and -2.4 (B) -2.4 and -0.4 (C) -0.4 and 0.0 (D) -2.4 and 0.0

Ans. (A)

Sol.

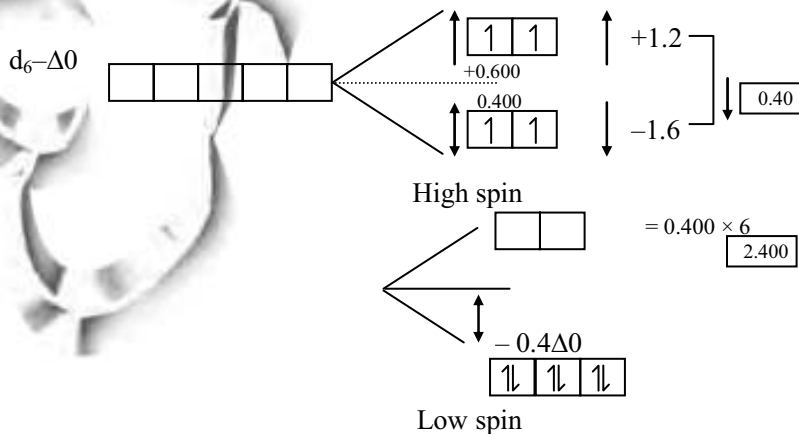

110. Emulsification of 10 ml of oil in water produces  $2.4 \times 10^{18}$  droplets. If the surface tension at the oil-water

interface is  $0.03 \text{ Jm}^2$  and the area of each droplet is  $12.5 \times 10^{-16} \text{ m}^2$ , the energy spent in the formation of oil droplets is-

- (A) 90 J                      (B) 30 J                      (C) 900 J                      (D) 10 J

**Ans. (A)**

**Sol.** Total droplets =  $2.4 \times 10^{18}$   
total area = total droplets  $\times$  area of one drop  
=  $2.4 \times 10^{18} \times 12.5 \times 10^{-16}$   
=  $12.5 \times 2.4 \times 10^2 \text{ m}^2$

Energy consumption  
=  $0.03 \times 12.5 \times 2.4 \times 10^2$   
= 90 Joule

## BIOLOGY

**111.** Which sequence of events gives rise to flaccid guard cells and stomatal closure at night ?

- (A) low [Glucose]  $\Rightarrow$  low osmotic pressure  $\Rightarrow$  low pH  $\Rightarrow$  high  $\text{pCO}_2$   
(B) low pH  $\Rightarrow$  high  $\text{pCO}_2$   $\Rightarrow$  low [Glucose]  $\Rightarrow$  low osmotic pressure  
(C) low osmotic pressure  $\Rightarrow$  high  $\text{pCO}_2$   $\Rightarrow$  low pH  $\Rightarrow$  low [Glucose]  
(D) high  $\text{pCO}_2$   $\Rightarrow$  low pH  $\Rightarrow$  low [Glucose]  $\Rightarrow$  low osmotic pressure

**Ans. (D)**

**112.** Rice has a diploid genome with  $2n = 24$ . If crossing-over is stopped in a rice plant and then selfed seeds are collected, will all the offsprings be genetically identical to the parent plant ?

- (A) yes, because crossing-over is the only source of genetic variation  
(B) no, because stopping of crossing-over automatically increases rate of point mutation  
(C) yes, only if the parent plant was a completely inbred line  
(D) yes, only if the parent plant was a hybrid between two pure-bred lines

**Ans. (C)**

**113.** Rodents can distinguish between many different types of odours. The basis for odour discrimination is that-

- (A) they have a small number of odorant receptors that bind to many different odorant molecules  
(B) the mechanoreceptors in the nasal cavity are activated by different odorant molecules found in the air passing through the nostrils  
(C) the part of the brain that processes the sense of smell has many different receptors for odorant molecules  
(D) a large number of different chemoreceptors are present in the nasal cavity that binds a variety of odorant molecules

**Ans. (D)**

**114.** Although blood flows through large arteries at high pressure, when the blood reaches small capillaries the pressure decreases because-

- (A) the valves in the arteries regulate the rate of blood flow into the capillaries  
(B) the volume of blood in the capillaries is much lesser than that in the arteries  
(C) the total cross-sectional area of capillaries arising from an artery is much greater than that of the artery  
(D) elastin fibers in the capillaries help to reduce the arterial pressure

**Ans. (C)**

**115.** *E.coli* about to replicate was pulsed with tritiated thymidine for 5 min and then transferred to normal

medium. After one cell division which one of the following observations would be correct ?

- (A) both the strands of DNA will be radioactive      (B) one strand of DNA will be radioactive  
(C) none of the strands will be radioactive      (D) half of one strand of DNA will be radioactive

**Ans. (B)**

**116.** Selection of lysine auxotroph (bacteria which requires lysine for growth) from a mixed population of bacteria can be done by growing the bacterial population in the presence of-

- (A) lysine      (B) penicillin      (C) lysine and penicillin      (D) glucose

**Ans. (D)**

**117.** Increasing the number of measurements of an experimental variable will-

- (A) increase the standard error of the sample      (B) increase the mean of the sample  
(C) decrease the standard error of the sample      (D) result in all of the above

**Ans. (C)**

**118.** For a human male what is the probability that all the maternal chromosomes will end up in the same gamete ?

- (A)  $1/23$       (B)  $2^{23}$       (C)  $2^{46}$       (D)  $(1/2)^{23}$

**Ans. (D)**

**119.** Nocturnal animals have retinas that contain-

- (A) a high percentage of rods to increase sensitivity to low light conditions  
(B) a high percentage of cones so that nocturnal color vision can be improved in low light conditions  
(C) an equal number of rods and cones so that vision can be optimized  
(D) retinas with the photoreceptor layer present in the front of the eye to increase light sensitivity

**Ans. (A)**

**120.** The length of one complete turn of a DNA double helix is-

- (A) 34 Å      (B) 34 nm      (C) 3.4 Å      (D) 3.4 μm

**Ans. (A)**